

Plain (215mm)
HD02
Weight: 46.2kg/m
Also 140mm high: HD01 (30.1kg/m)
Also 290mm high: HD03 (62.4kg/m)

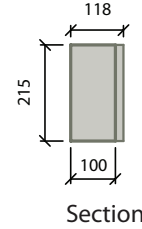

Flush Plain Keystone
HD04
Weight: 46.2kg/m

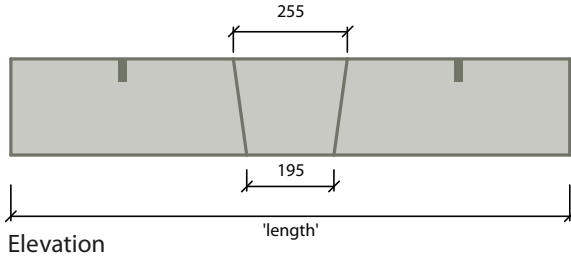
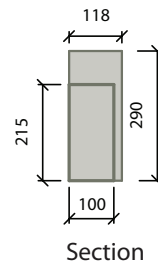
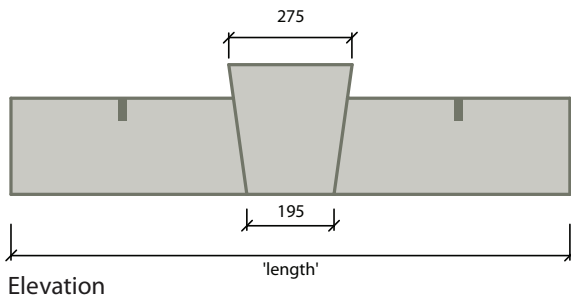

Extended Plain Keystone
HD05
Weight: 46.2kg/m + 6.9kg

Splayed Heads

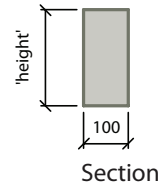

Plain (215mm)
HD09
Weight: 46.2kg/m**
Also 140mm high: HD08 (30.1kg/m**)
Also 290mm high: HD10 (62.4kg/m**)

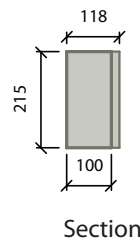
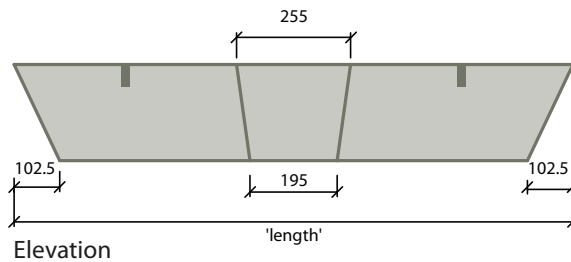

Flush Plain Keystone
HD11
Weight: 46.2kg/m**

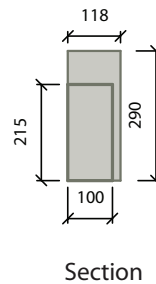
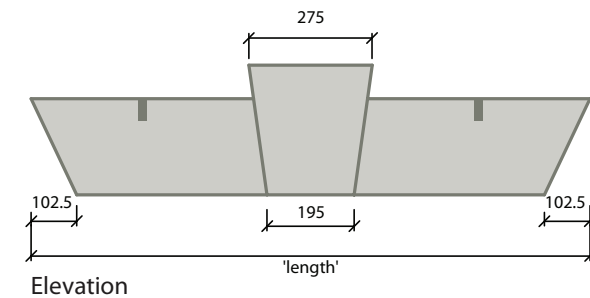

Extended Plain Keystone
HD12
Weight: 46.2kg/m** + 6.9kg

■ shows position of lifting inserts if required

Standard Heads are available to suit Rendered buildings.